

BEFORE YOU BEGIN

Do not cut parts off frame before studying each picture thoroughly. Before cutting, match each part number (located on small tabs on the frame) with the corresponding number in each assembly diagram.

Now starting with step 1, use your safety scissors to cut the parts off the frame as needed. Remove excess plastic where part was cut from frame.

Continue to put your Zoid together part by part. They snap together and do not require glue. When you're done just wind him up and watch the action start.

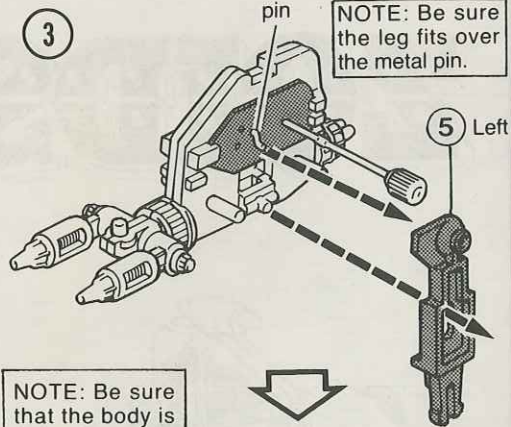
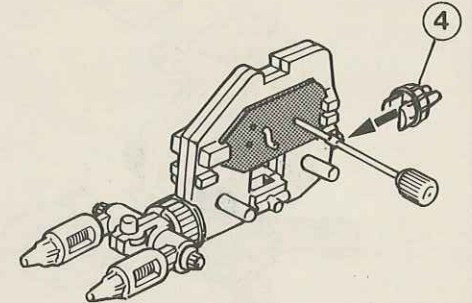
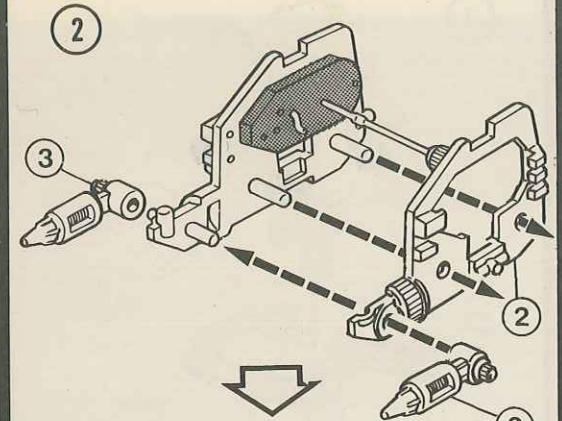
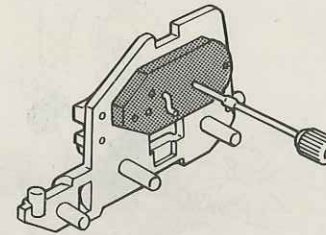
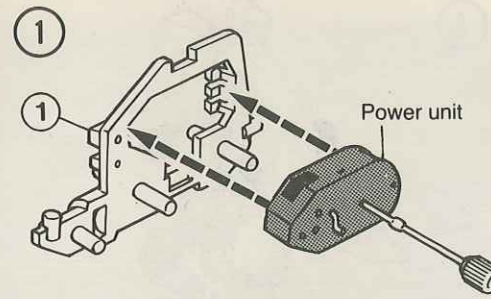
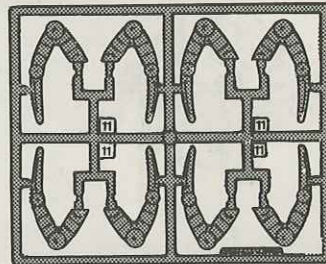
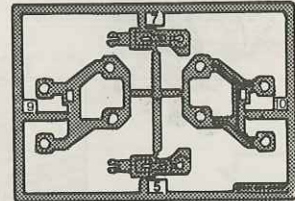
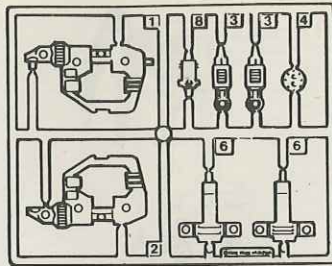
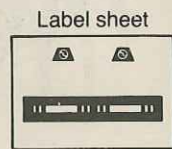
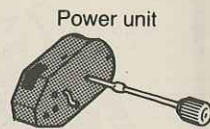
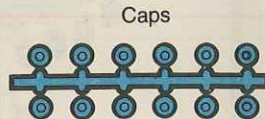
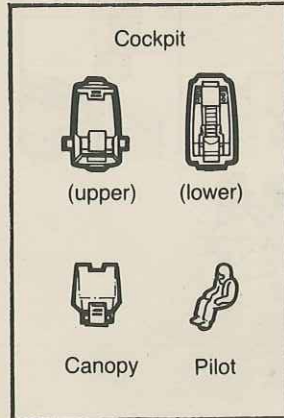

NOTE: Be sure that the body is right side up before attaching legs.

